



## 特点

- 非绝缘，底板为公共电极
- 优良的温度特性和功率循环能力
- 低正向压降

## 典型应用

- 电焊机电源
- 各种DC电源
- 变频器

V <sub>RRM</sub>	型号
500V-2500V	MTG200A500-2500V三社

符号	参数	测试条件	结温 T <sub>J</sub> (°C)	参数值			温位
				最小	典型	最大	
I <sub>T(AV)</sub>	通态平均电流	180° 正弦半波, 50Hz 单面散热, T <sub>C</sub> =85°C	125			200	A
I <sub>T(RMS)</sub>	方均根电流		125			314	A
V <sub>DRM</sub> V <sub>RRM</sub>	断态重复峰值电压 反向重复峰值电压	V <sub>DRM</sub> &V <sub>RRM</sub> tp=10ms	125	500		2500	V
I <sub>DRM</sub> I <sub>RRM</sub>	断态重复峰值电流 反向重复峰值电流	at V <sub>DRM</sub> at V <sub>RRM</sub>	125			20	mA
I <sub>TSM</sub>	通态不重复浪涌电流	10ms 底宽, 正弦半波	125			6.50	KA
I <sup>2</sup> t	浪涌电流平方时间积	V <sub>R</sub> =0.6V <sub>RRM</sub>				215	10 <sup>3</sup> A <sup>2</sup> S
V <sub>TO</sub>	门槛电压		125			0.80	V
r <sub>T</sub>	斜率电阻					1.27	mΩ
V <sub>TM</sub>	通态峰值电压	I <sub>TM</sub> =628A	25			1.62	V
dv/dt	断态电压临界上升率	V <sub>DM</sub> =0.67V <sub>DRM</sub>	125			1000	V/us
di/dt	通态电流临界上升率	I <sub>MT</sub> =52A 门极触发电流幅值 I <sub>GR</sub> =1.5A 门极电流上升时间 t <sub>r</sub> ≤0.5us	125			150	A/us
I <sub>GT</sub>	门极触发电流	V <sub>A</sub> =12V, I <sub>A</sub> =1A	25	25		100	mA
V <sub>GT</sub>	门极触发电压			0.6		1.5	V
I <sub>H</sub>	维持电流			20		150	mA
V <sub>GD</sub>	门极不触发电压	V <sub>DM</sub> =0.67V <sub>DRM</sub>	125			0.2	V
R <sub>th(j-c)</sub>	热阻抗 (结至壳)	单面散热				0.130	°C/W
R <sub>th(c-h)</sub>	热阻抗 (壳至散)	单面散热				0.1	°C/W
F <sub>M</sub>	安装扭矩 (M6)			4.5		6.0	N-m
	安装扭矩 (M6)			4.5		6.0	N-m
T <sub>stq</sub>	储存温度			-40		125	°C
W <sub>t</sub>	质量						g
Outline	外形						

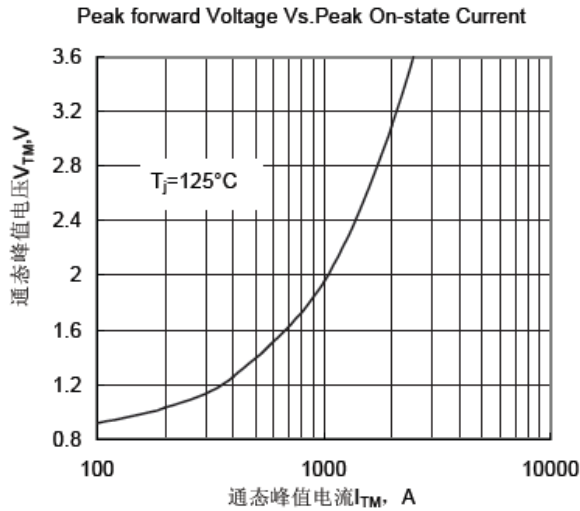

Fi-1 通态伏安特性曲线

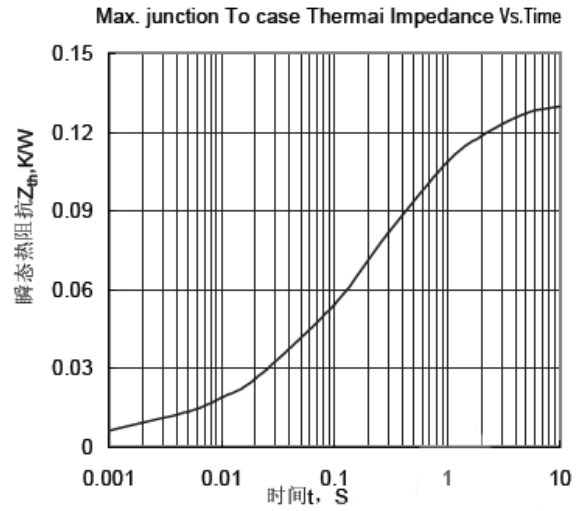

Fi-2 结至管壳至态热阻抗曲线

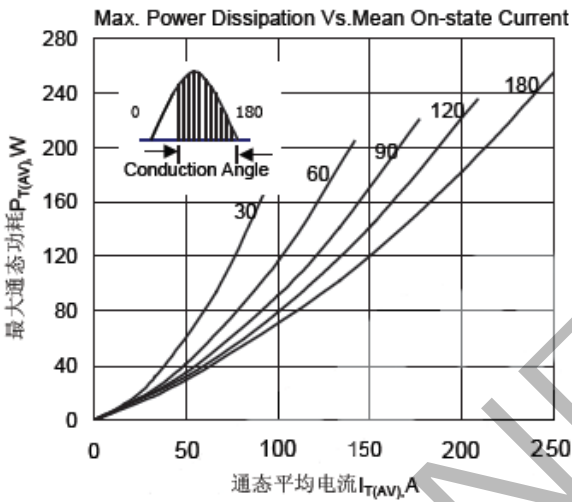

Fi-3 最大功耗与通态平均电流关系曲线

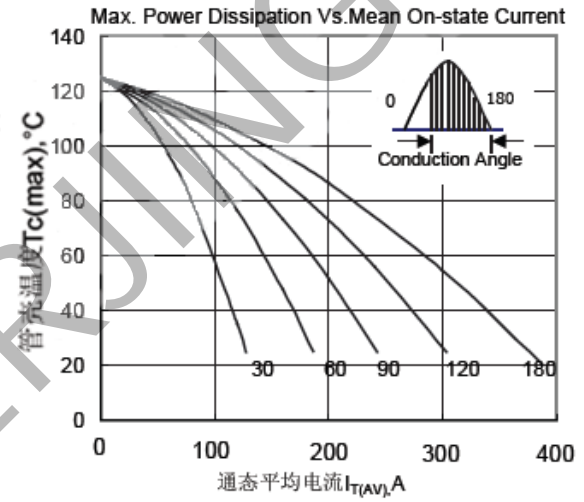

Fi-4 管壳温度与通态平均电流关系曲线

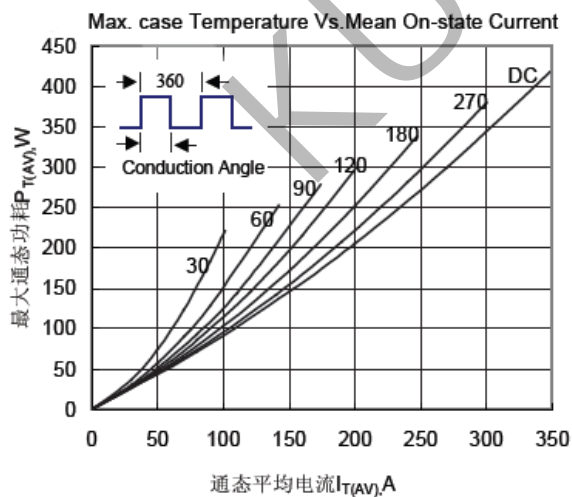

Fi-5 最大功耗与通态电流关系曲线

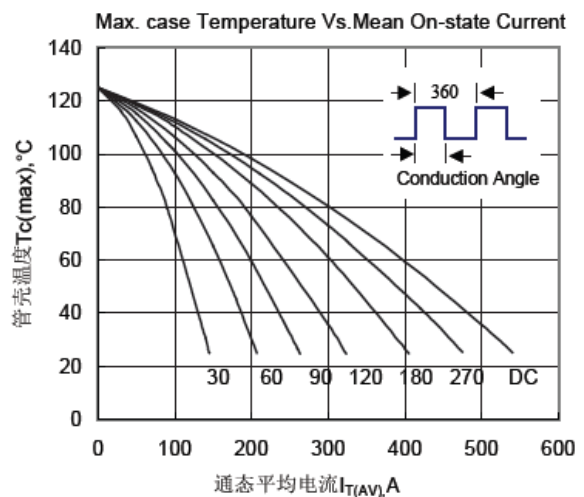

Fi-6 管壳温度与通态平均电流关系曲线

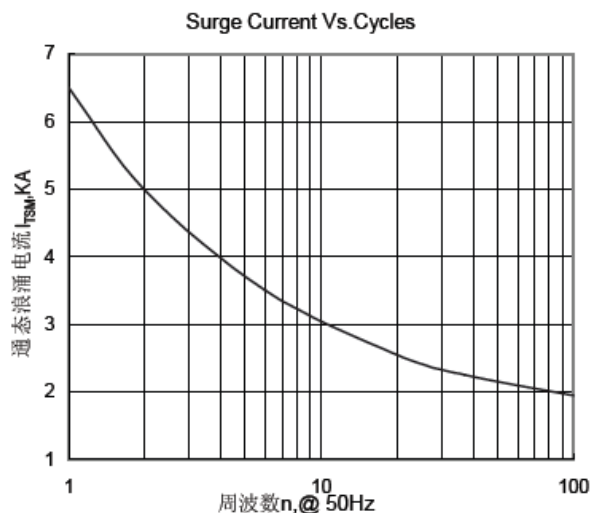

Fi-7 通态浪涌电流与周波数的关系曲线

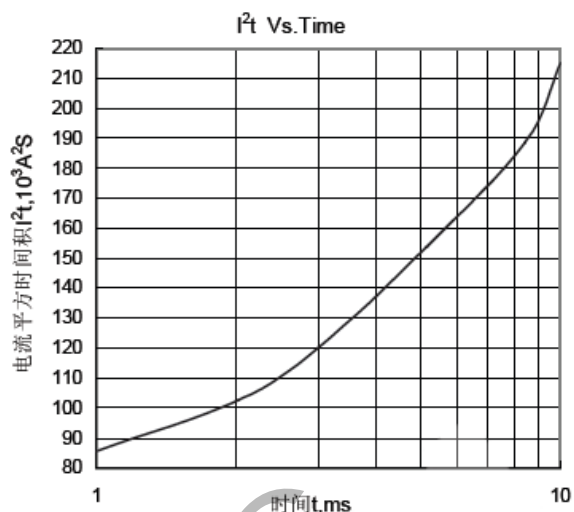

Fi-8 I<sup>2</sup>t 特性曲线

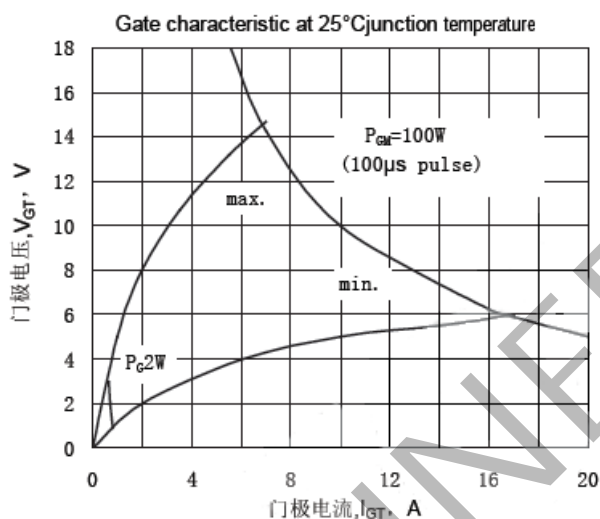

Fi-9 门极功率曲线

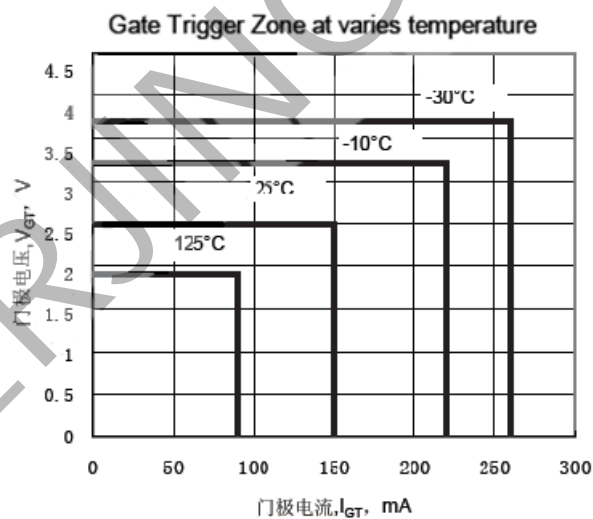

Fi-10 门极触发特性曲线

外形图:



图 1



线路图:

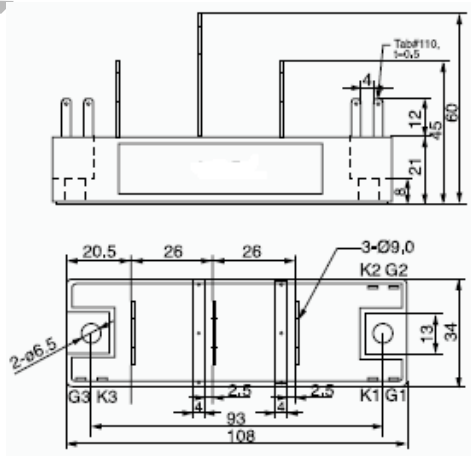
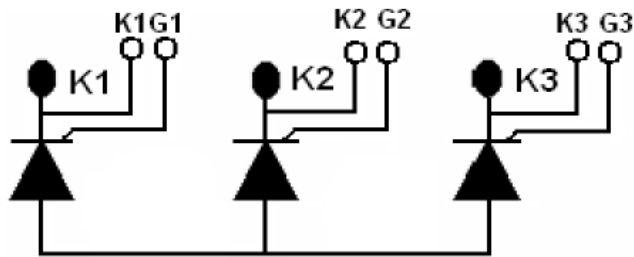

MTG

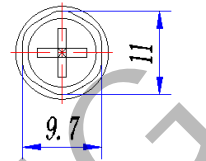
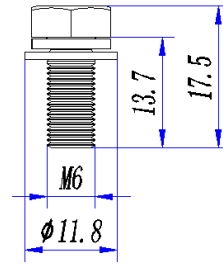

KUNERJING